



D-TORR

DATE DRAWN: 8/26/19

INSERT REV TABLE BELOW

REVISIONS		
REV.	DESCRIPTION	DATE

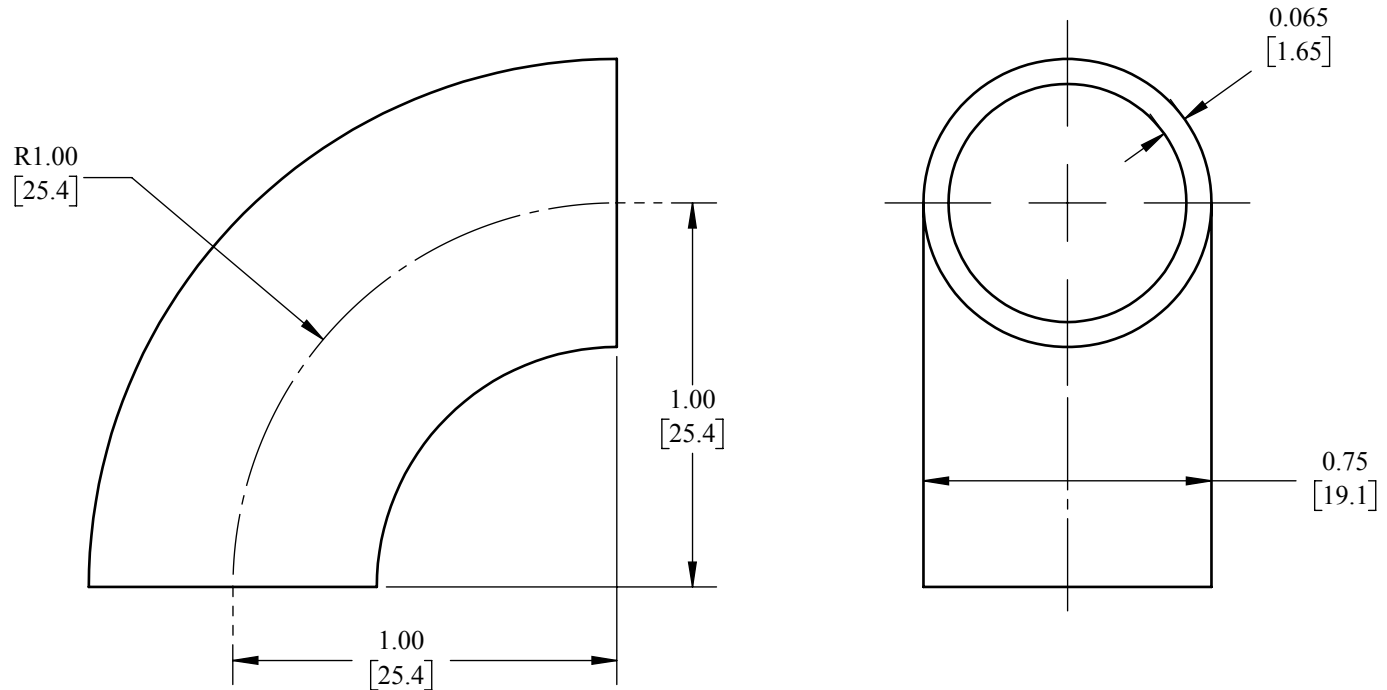

**DRAWING
NOT TO SCALE**

UNITS: IN [MM] | PRODUCT CONTACT MAX. SURFACE FINISH: POLISHED | WEIGHT: | MATERIAL: 304 SS | DRAFTER: MWR

**DESCRIPTION:
D-TORR 90 DEG ELBOW**

**PART #
DVF-C075G1Q**

PROPRIETARY AND CONFIDENTIAL

THIS DRAWING IS OWNED BY DIXON VALVE & COUPLING CO. AND SHALL BE RETURNED UPON DEMAND. IT IS LOANED ON CONDITION THAT IT SHALL NOT BE COPIED OR REPRODUCED OR SBMITTED TO OTHERS WITHOUT THE OWNER'S CONSENT. IN ACCEPTING IT SUBJECT TO THIS CONDITION THE RECIPIENT FURTHER AGREES THAT THIS DRAWING OR ANY DESIGN DETAIL OR CONCEPT DESCLOED HEREIN SHALL NOT BE USED IN ANY WAY DETRIMENTAL TO OR IN COMPETITION WITH THE OWNER. IF THE RECIPIENT DOES NOT AGREE TO THE TERMS OF THIS AGREEMENT THEY SHALL RETURN THIS DRAWING IMMEDIATELY. THE INFORMATION CONTAINED IN THIS DRAWING IS SUBJECT TO CHANGE WITHOUT NOTICE.



The Right Connection®